

THREE-PHASE SPINDLE MOTOR DRIVER FOR MONOLITHIC CD-ROM
DESCRIPTION

The μ PD16858B/C is a three-phase spindle motor driver for CD-ROM drives and consists of a CMOS control circuit and a MOS bridge output.

This motor driver employs a three-phase full-wave PWM driving method. Because it has an output stage consisting of MOS FETs, the motor driver consumes less power than the existing linear drivers using bipolar transistors.

The product is supplied in the form of a small, slim 30-pin shrink SOP.

This spindle motor driver is ideal for driving slim-type spindle motors in notebook PCs and so on.

FEATURES

- Both normal PWM type (16858B) and synchronous rectification PWM type (16858C) are available.
- Low ON resistance (sum of ON resistances of upper and lower MOS FETs): $R_{ON} = 0.8 \Omega$ (TYP)
- Low power consumption to three-phase full-wave PWM driving
- START/STOP pin is provided. Brake is applied in STOP mode.
- Standby pin is provided. Internal circuitry is turned off in standby mode.
- Low current consumption: $I_{DD} = 3 \text{ mA (MAX)}$, $I_{DD (ST)} = 1 \mu\text{A (MAX)}$, torque command current = $30 \mu\text{A (MAX)}$
- Thermal shut-down circuit and current-limiting circuit
- Low-voltage malfunctioning prevention circuit
- FG output function
- Reverse rotation prevention circuit
- Hole bias function
- 30-pin shrink SOP (300 mil)

ORDERING INFORMATION

| Part Number | Package |
|----------------------|--|
| μ PD16858BGS-GJG | 30-pin shrink SOP (0.65-mm pitch, 300 mil) |
| μ PD16858CGS-GJG | 30-pin shrink SOP (0.65-mm pitch, 300 mil) |

The information in this document is subject to change without notice. Before using this document, please confirm that this is the latest version.
 Not all devices/types available in every country. Please check with local NEC representative for availability and additional information.

ABSOLUTE MAXIMUM RATINGS

(T_A = 25 °C, 1 Ω/1 mH load condition: mounted on glass epoxy substrate measuring 100 mm × 100 mm × 1 mm with 15% of copper foil)

| Parameter | Symbol | Condition | Rating | Unit |
|---|-------------------------|------------------------|-------------------------------|---------|
| Supply voltage | V _{DD} | | -0.5 to +5.7 | V |
| | V _M | | -0.5 to +5.7 | V |
| Input voltage | V _{IN} | | -0.5 to V _{DD} + 0.5 | V |
| Steady-state DC output current ^{Note 1} | I _{D (DC)} | DC | ±0.5 | A/phase |
| Steady-state instantaneous output current ^{Note 2} | I _{D (pulse)} | PW ≤ 5 ms, Duty ≤ 30 % | ±1.3 | A/phase |
| Output current at reverse brake ^{Note 3} | I _{DR (pulse)} | PW ≤ 5 ms, Duty ≤ 30 % | ±1.5 | A/phase |
| Power consumption | P _T | | 1.0 | W |
| Peak joint temperature | T _{CH (MAX)} | | 150 | °C |
| Storage temperature range | T _{stg} | | -55 to +150 | °C |

- Notes**
1. Rated current at constant-speed revolution
 2. Rated current on starting or locking
 3. Rated current at reverse brake

RECOMMENDED OPERATING CONDITIONS

(T_A = 25 °C, 1 Ω/1 mH load condition: mounted on glass epoxy substrate measuring 100 mm × 100 mm × 1 mm with 15% of copper foil)

| Parameter | Symbol | MIN. | TYP. | MAX. | Unit |
|---|-------------------------|------|------|------|---------|
| Supply voltage | V _{DD} | 4.5 | | 5.5 | V |
| | V _M | 4.5 | | 5.5 | V |
| Steady-state DC output current ^{Note 1} | I _{D (DC)} | | | ±0.4 | A/phase |
| Steady-state instantaneous output current ^{Note 2} | I _{D (pulse)} | | | ±1.0 | A/phase |
| Output current at reverse brake ^{Note 3} | I _{DR (pulse)} | | | ±1.2 | A/phase |
| Hole bias current | I _{HB} | | 10 | 20 | mA |
| IND pin output current | I _{FG} | 0 | ±2.5 | ±5 | mA |
| Operating temperature range | T _A | -20 | | 75 | °C |

- Notes**
1. Recommended maximum current at constant-speed revolution
 2. Recommended maximum current on starting or locking (It is recommended that the current be limited to 1.0 A or less.)
 3. Recommended maximum current at reverse brake

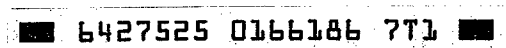

ELECTRICAL SPECIFICATIONS (Unless otherwise specified, T_A = 25 °C, V_{DD} = V_M = 5 V)

| Parameter | Symbol | Condition | MIN. | TYP. | MAX. | Unit |
|--|------------------------|--|----------------------|------|-----------------|------|
| [Overall] | | | | | | |
| Current consumption 1 (during operation) | I _{DD} | STB = V _{DD} | | | 3.0 | mA |
| Current consumption (in standby mode) | I _{DD (ST)} | STB = GND | | | 1.0 | μA |
| [ST/SP, STB, REV] | | | | | | |
| High-level input voltage | V _{IH} | | 0.6 V _{DD} | | V _{DD} | V |
| Low-level input voltage | V _{IL} | | | | 0.8 | V |
| Input pull-down resistor | R _{IND} | | | 120 | | kΩ |
| [Control circuit] | | | | | | |
| Triangular wave oscillation frequency | f _{PWM} | C _T = 100 pF | | 75 | | kHz |
| [Hole amplifier] | | | | | | |
| In-phase input voltage range | V _{Hch} | | 1.5 | | 3.5 | V |
| Hysteresis voltage | V _{Hhs} | V _H = 2.5 V | | 15 | | mV |
| Input bias current | I _{Hbias} | | | | 1.0 | μA |
| [Hole bias block] | | | | | | |
| Hole bias voltage | V _{HB} | I _{HB} = 10 mA | | 0.3 | 0.5 | V |
| [FG output] | | | | | | |
| IND pin high-level voltage | V _{FQ,H} | I _{FG} = -2.5 mA | V _{DD} -1.0 | | | V |
| IND pin low-level voltage | V _{FQ,L} | I _{FG} = +2.5 mA | | | 0.5 | V |
| [Output block] | | | | | | |
| Output ON resistance (upper + lower) | R _{ON} | I _{DR} = 200 mA T _A = -20 to +75 °C | | 0.8 | 1.2 | Ω |
| OFF leakage current | I _{D (OFF)} | | | | 10 | μA |
| Output turn-on time | t _{ONH} | R _M = 5 Ω | | | 1.0 | μs |
| Output turn-off time | t _{OFFH} | Star wiring | | | 1.0 | μs |
| [Torque command] | | | | | | |
| Control reference input voltage range | ECR | | 0.3 | | 4.0 | V |
| Control input voltage range | EC | | 0.3 | | 4.0 | V |
| Input current | I _{IN} | EC, ECR = 0.5 to 3 V | | | 30 | μA |
| Input voltage difference | ECR-EC ^{Note} | DUTY = 100 %, ECR = 2.0 V | | 1.1 | | V |
| DEAD ZONE (+) | EC_d+ | ECR = 2.0 V | 0 | | 100 | mV |
| DEAD ZONE (-) | EC_d- | ECR = 2.0 V | 0 | | -100 | mV |
| [Overcurrent detector] | | | | | | |
| Input offset voltage | V _{IO} | | -15 | | +15 | mV |
| CL pin voltage | V _{CL} | | | 100 | | mV |

Note Excluding the dead zone.

The overheating protection circuit (T.S.D) operates at T_{CH} > 150 °C.

The low-voltage malfunctioning prevention circuit (UVLO) operates at 4 V (TYP).

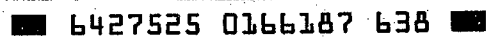

PIN FUNCTION

Package: 30-pin shrink SOP (300 mil)

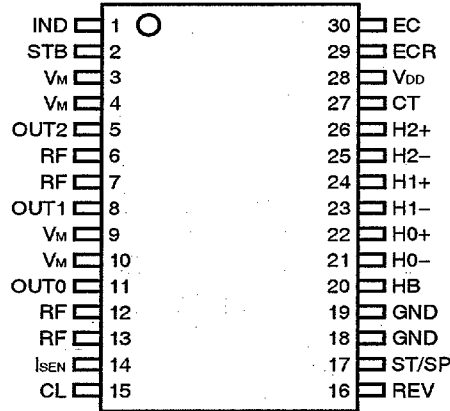

| Pin No | Pin Name | Pin Function |
|--------|------------------|--|
| 1 | IND | Index signal output pin |
| 2 | STB | Standby operation input pin |
| 3 | V _M | Motor block supply voltage input pin |
| 4 | V _M | Motor block supply voltage input pin |
| 5 | OUT2 | Motor connection pin |
| 6 | RF | Three-phase bridge common pin |
| 7 | RF | Three-phase bridge common pin |
| 8 | OUT1 | Motor connection pin |
| 9 | V _M | Motor block supply voltage input pin |
| 10 | V _M | Motor block supply voltage input pin |
| 11 | OUT0 | Motor connection pin |
| 12 | RF | Three-phase bridge common pin |
| 13 | RF | Three-phase bridge common pin |
| 14 | I _{SEN} | Sense resistor connection pin |
| 15 | CL | Overcurrent detection voltage filter pin |
| 16 | REV | Reverse operation input pin |
| 17 | ST/SP | Start/stop input pin |
| 18 | GND | GND pin |
| 19 | GND | GND pin |
| 20 | HB | Hole bias pin |
| 21 | H0- | Hole signal input pin |
| 22 | H0+ | Hole signal input pin |
| 23 | H1- | Hole signal input pin |
| 24 | H1+ | Hole signal input pin |
| 25 | H2- | Hole signal input pin |
| 26 | H2+ | Hole signal input pin |
| 27 | C _T | Oscillation frequency setting capacitor connection pin |
| 28 | V _{DD} | Control system supply voltage input pin |
| 29 | ECR | Control reference voltage input pin |
| 30 | EC | Control voltage input pin |

Remark Where more than one pin with the same name exists (such as V_M, RF, and GND), connect all of them, not just one of them.

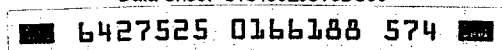

BLOCK DIAGRAM

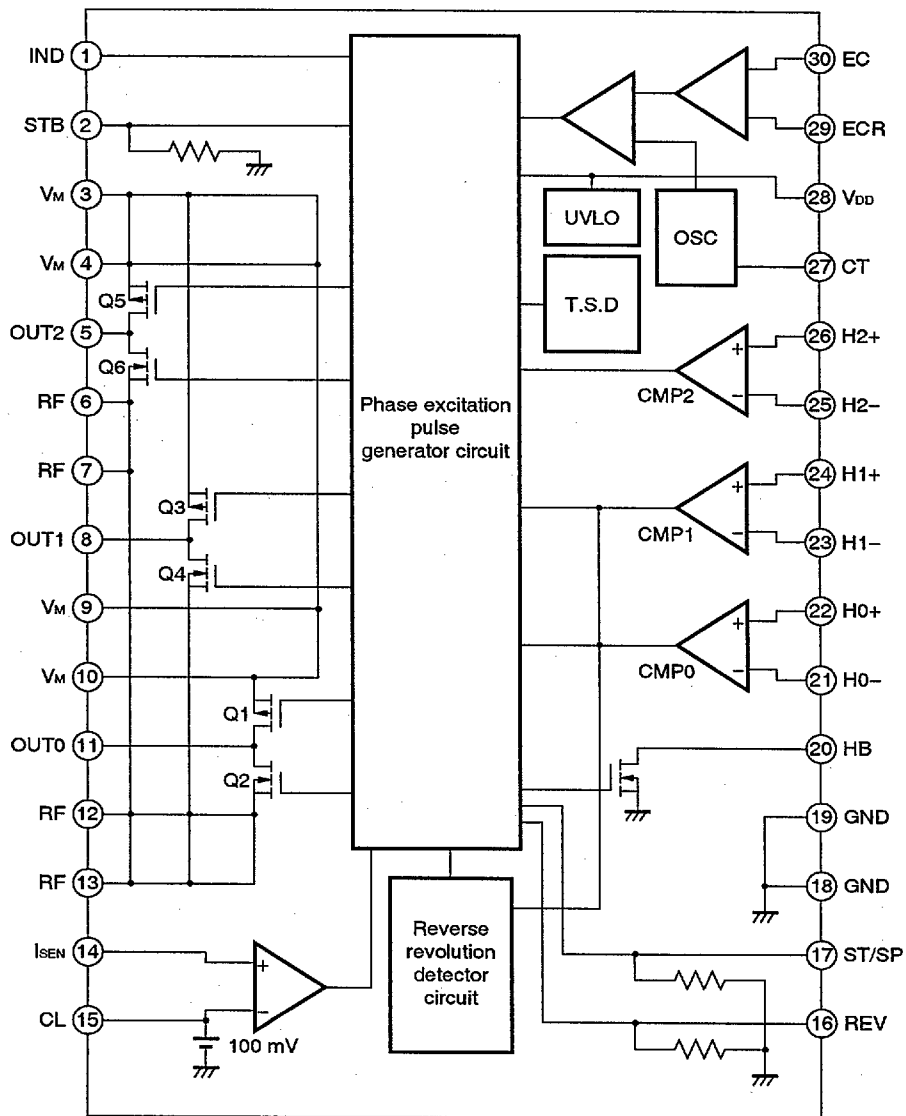

- Remarks**
1. The CL pin is used to connect a filter. Leave this pin open when it is not used.
 2. Where more than one pin with the same name exists (such as V_m, RF, and GND), connect all of them, not just one of them.

TOTAL LOSS VS AMBIENT TEMPERATURE CHARACTERISTICS

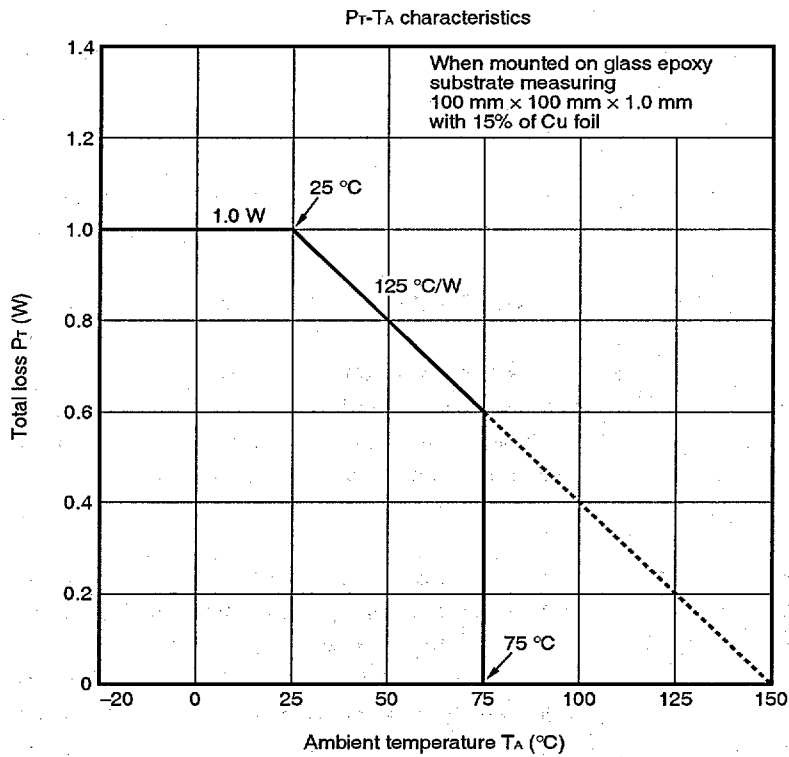

Caution If the ambient temperature is 25 °C or less, a power of up to 1 W can be applied. If the temperature rises beyond 25 °C, perform derating by referring to the above figure. At 75 °C, which is the maximum level of the recommended operating temperature, a power of up to 0.6 W can be applied to the IC.

FUNCTION OPERATION TABLE

(1) ST/SP = "H"

| Input Signal | | | | Circuit Operation Mode | Source → Sink |
|--------------|------|------|-----|------------------------|---------------|
| CMP0 | CMP1 | CMP2 | PWM | | |
| H | H | L | H | Operate | W → V |
| H | H | L | L | Brake | |
| H | L | L | H | Operate | W → U |
| H | L | L | L | Brake | |
| H | L | H | H | Operate | V → U |
| H | L | H | L | Brake | |
| L | L | H | H | Operate | V → W |
| L | L | H | L | Brake | |
| L | H | H | H | Operate | U → W |
| L | H | H | L | Brake | |
| L | H | L | H | Operate | U → V |
| L | H | L | L | Brake | |

Brake: Regenerated via parasitic diode of high-side Pch MOS FET (μPD16858B).
 Regenerated via high-side Pch MOS FET channel (μPD16858C).

(2) ST/SP = "L"

| Input Signal | | | | Circuit Operation Mode |
|--------------|------|------|-----|------------------------|
| CMP0 | CMP1 | CMP2 | PWM | |
| - | - | - | - | Short brake |

Short brake: High-side MOS FET turns ON and low-side MOS FET turns OFF.

(3) Torque command

The relation between the difference between the control reference voltage (ECR) and control voltage (EC) (ECR - EC) and torque is as follows:

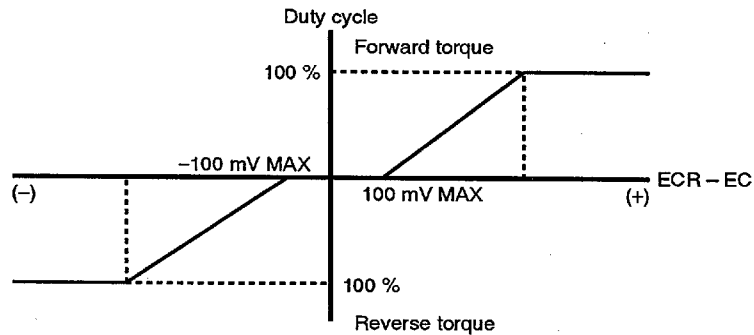

| | Reverse Pin Voltage (REV) | |
|----------|---------------------------|-------------------------|
| | L | H |
| ECR > EC | Forward | Reverse ^{Note} |
| ECR < EC | Reverse ^{Note} | Stop |

Note Stops if reverse revolution is detected.
 During reverse revolution, the counter electromotive current flows through the parasitic diode of the Pch MOS FET at the high side (μPD16858B), or the channel of Pch MOS FET at the high side (μPD16858C).

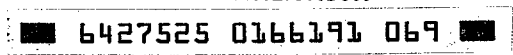

(4) Standby mode

The power supplied to the internal circuitry of the IC can be turned off by setting the IC in the standby mode. In the standby mode, each pin goes into a high-impedance state (H bridge all OFF). The internal oscillation block also stops and therefore, the circuit current can be decreased.

If the motor driver is stopped by using the standby pin while the driver is operating, the motor is stopped by force of inertia. It takes the motor driver about several 10 μs to start when it is set in the normal operation mode.

| STB Pin | Operation Mode |
|---------|----------------|
| H | Normal mode |
| L | Standby mode |

Caution Output current

The rated output current differs depending on whether the motor revolves at a constant speed (steady state), is started (steady state), or reversed and brake is applied. The rated DC current when the motor revolves at a constant speed is 0.5 A, and the rated instantaneous current when the motor is started is 1.3 A. When brake is applied to stop the motor and when the motor is reversed, the maximum current is 1.5 A.

When a brake is applied or the motor is reversed, a current exceeding that when the motor revolves at a constant speed (immediately before a brake is applied) instantaneously flows because of the counter electromotive force due to the motor inductance. Determine the value of overcurrent for the steady state, taking the peak current for reversing or applying a brake to the motor into consideration.

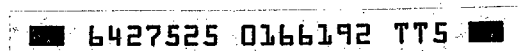

TIMING CHARTS

(1) Hole signal input

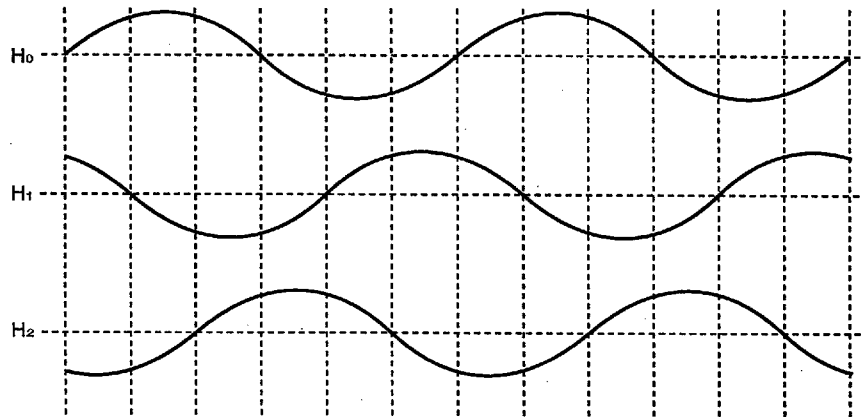

(2) CMP signal

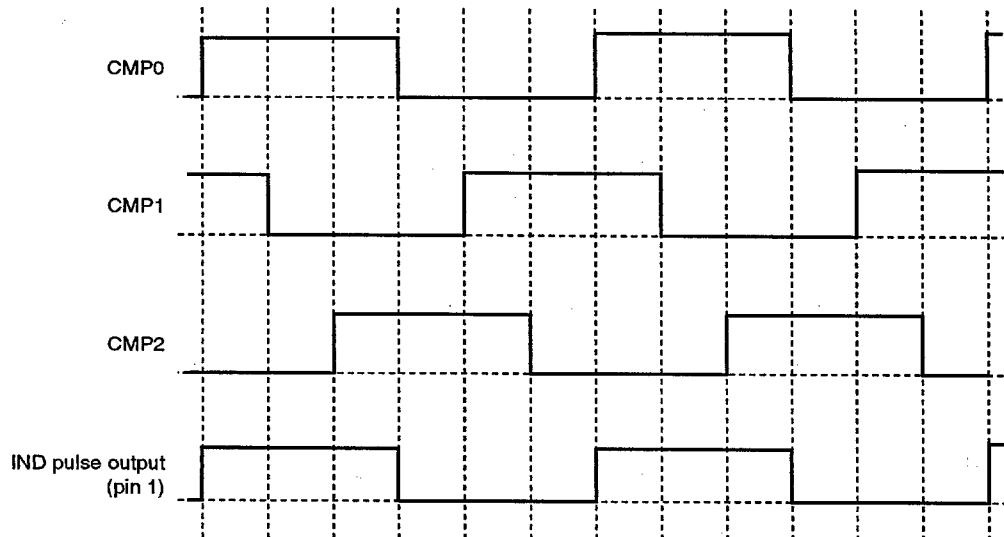

(3) Output MOS FET driving and comparator selection (blank: switch OFF)

| | | | | | | | | | | | | | |
|----|------|------|------|------|------|------|------|------|------|------|------|------|------|
| Q1 | | (SW) | (SW) | | ON | ON | | (SW) | (SW) | | ON | ON | |
| Q2 | | SW | SW | | | | | SW | SW | | | | |
| Q3 | (SW) | | ON | ON | | (SW) | (SW) | | ON | ON | | (SW) | (SW) |
| Q4 | SW | | | | | SW | SW | | | | | SW | SW |
| Q5 | ON | ON | | (SW) | (SW) | | ON | ON | | (SW) | (SW) | | ON |
| Q6 | | | | SW | SW | | | | | SW | SW | | |

The high-side MOS FET at the output stage of the μPD16858C performs synchronous switching (switching in parentheses).

The high-side MOS FET of the μPD16858B does not perform switching in parentheses but is in the OFF state.

(4) Motor driving wave

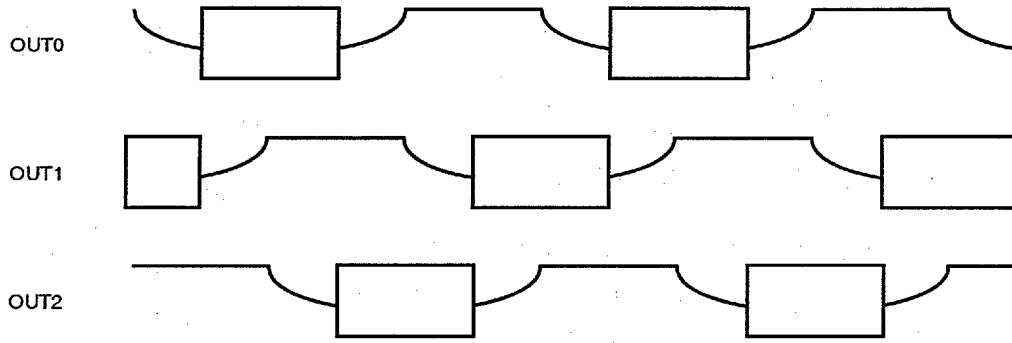

APPLICATION CIRCUIT EXAMPLE

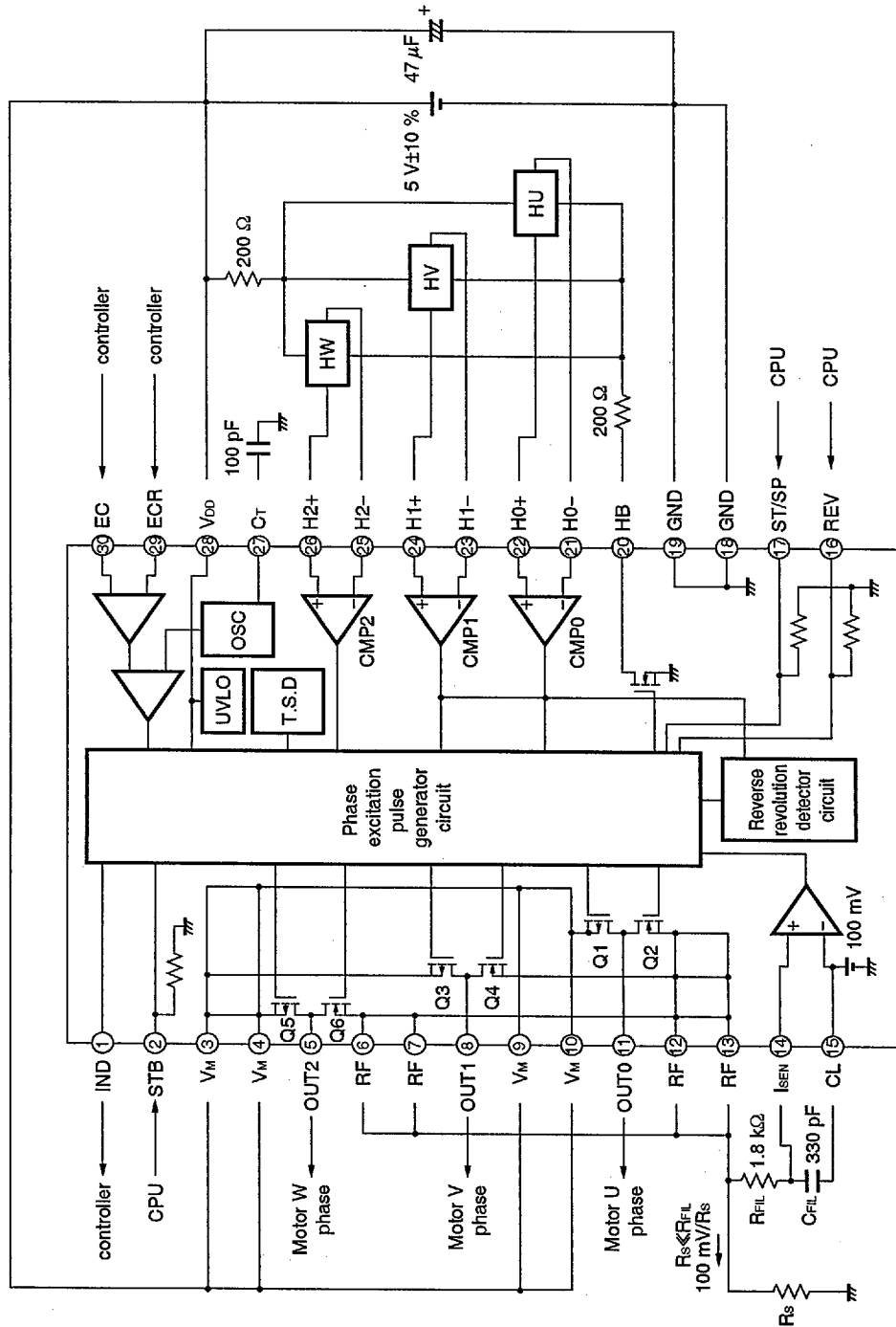

Caution It is recommended that a tantalum capacitor of several 10 μF be inserted between V_m and GND to reduce noise during PWM. Determine the value of R_s so that the output current does not exceed the rating.

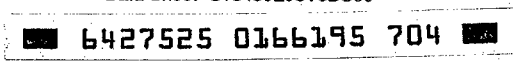

PACKAGE DRAWING

30 PIN PLASTIC SHRINK SOP (300 mil)

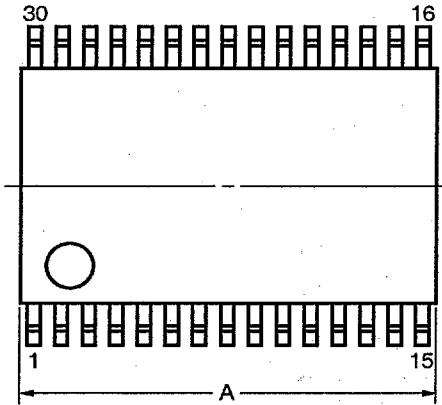

detail of lead end

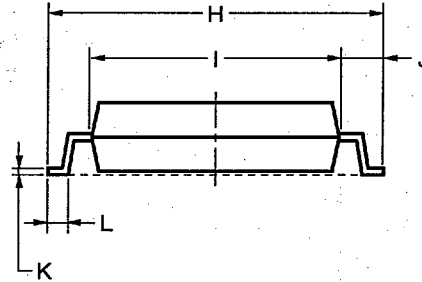
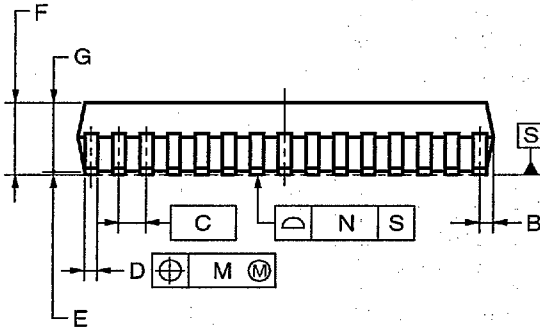
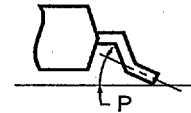

NOTES

1. Controlling dimension — millimeter.
2. Each lead centerline is located within 0.10 mm (0.004 inch) of its true position (T.P.) at maximum material condition.

| ITEM | MILLIMETERS | INCHES |
|------|--|---|
| A | 9.85±0.26 | 0.388±0.011 |
| B | 0.51 MAX. | 0.020 MAX. |
| C | 0.65 (T.P.) | 0.026 (T.P.) |
| D | 0.32 ^{+0.08} _{-0.07} | 0.013 ^{+0.003} _{-0.004} |
| E | 0.125±0.075 | 0.005±0.003 |
| F | 2.0 MAX. | 0.079 MAX. |
| G | 1.7±0.1 | 0.067±0.004 |
| H | 8.1±0.2 | 0.319±0.008 |
| I | 6.1±0.2 | 0.240±0.008 |
| J | 1.0±0.2 | 0.039 ^{+0.009} _{-0.008} |
| K | 0.17 ^{+0.08} _{-0.07} | 0.007 ^{+0.003} _{-0.004} |
| L | 0.5±0.2 | 0.020 ^{+0.008} _{-0.009} |
| M | 0.10 | 0.004 |
| N | 0.10 | 0.004 |
| P | 3° ^{+7°} _{-3°} | 3° ^{+7°} _{-3°} |

P30GS-65-300B-2

RECOMMENDED SOLDERING CONDITONS

Solder this product under the following recommended conditions.

For details of the recommended soldering conditions, refer to information document **Semiconductor Device Mounting Technology Manual (C10535E)**.

For soldering methods and conditions other than those recommended, consult NEC.

| Soldering Method(s) | Soldering Conditions | Recommended Conditions Symbol |
|---------------------|--|-------------------------------|
| Infrared reflow | Package peak temperature: 235 °C, Time: 30 sec max. (210 °C min.), Number of times: three times max., Number of days: None ^{Note} , Flux: Rosin-based flux with little chlorine content (chlorine: 0.2 Wt% max.) is recommended. | IR35-00-3 |
| VPS | Package peak temperature: 215 °C, Time: 40 sec max. (200 °C min.), Number of times: three times max., Number of days: None ^{Note} , Flux: Rosin-based flux with little chlorine content (chlorine: 0.2 Wt% max.) is recommended. | VP15-00-3 |
| Wave soldering | Package peak temperature: 260 °C, Time: 10 sec max., Preheating temperature: 120 °C max., Number of times: once, Flux: Rosin-based flux with little chlorine content (chlorine: 0.2 Wt% max.) is recommended. | WS60-00-1 |

Note Number of days in storage after the dry pack has been opened. The storage conditions are at 25 °C, 65% RH MAX.

Caution Do not use two or more soldering methods in combination.

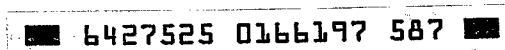

[MEMO]

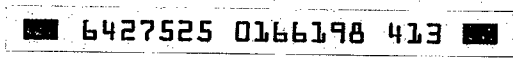

[MEMO]

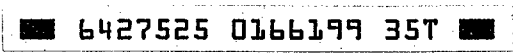

- **The information in this document is subject to change without notice. Before using this document, please confirm that this is the latest version.**
 - No part of this document may be copied or reproduced in any form or by any means without the prior written consent of NEC Corporation. NEC Corporation assumes no responsibility for any errors which may appear in this document.
 - NEC Corporation does not assume any liability for infringement of patents, copyrights or other intellectual property rights of third parties by or arising from use of a device described herein or any other liability arising from use of such device. No license, either express, implied or otherwise, is granted under any patents, copyrights or other intellectual property rights of NEC Corporation or others.
 - Descriptions of circuits, software, and other related information in this document are provided for illustrative purposes in semiconductor product operation and application examples. The incorporation of these circuits, software, and information in the design of the customer's equipment shall be done under the full responsibility of the customer. NEC Corporation assumes no responsibility for any losses incurred by the customer or third parties arising from the use of these circuits, software, and information.
 - While NEC Corporation has been making continuous effort to enhance the reliability of its semiconductor devices, the possibility of defects cannot be eliminated entirely. To minimize risks of damage or injury to persons or property arising from a defect in an NEC semiconductor device, customers must incorporate sufficient safety measures in its design, such as redundancy, fire-containment, and anti-failure features.
 - NEC devices are classified into the following three quality grades:
"Standard", "Special", and "Specific". The Specific quality grade applies only to devices developed based on a customer designated "quality assurance program" for a specific application. The recommended applications of a device depend on its quality grade, as indicated below. Customers must check the quality grade of each device before using it in a particular application.
 - Standard: Computers, office equipment, communications equipment, test and measurement equipment, audio and visual equipment, home electronic appliances, machine tools, personal electronic equipment and industrial robots
 - Special: Transportation equipment (automobiles, trains, ships, etc.), traffic control systems, anti-disaster systems, anti-crime systems, safety equipment and medical equipment (not specifically designed for life support)
 - Specific: Aircraft, aerospace equipment, submersible repeaters, nuclear reactor control systems, life support systems or medical equipment for life support, etc.
- The quality grade of NEC devices is "Standard" unless otherwise specified in NEC's Data Sheets or Data Books. If customers intend to use NEC devices for applications other than those specified for Standard quality grade, they should contact an NEC sales representative in advance.

M7 98.8

6427525 0166200 9T1